

SECTION A-A

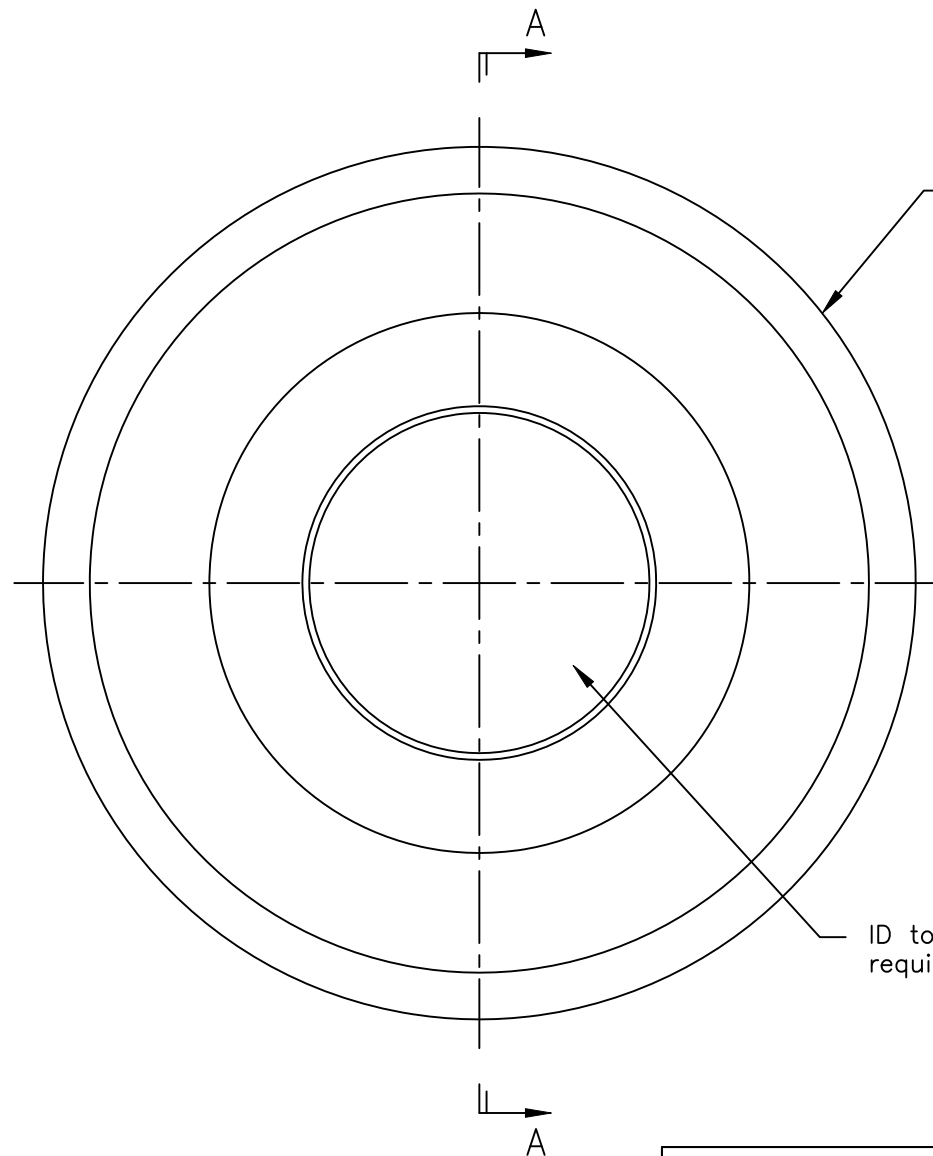

Cutting edge per customer requirements. Typically anywhere from a sharp edge up to a .007" radius.

Custom edges with other radii are also available.

ID tolerance per customer requirements.

WEB PRINT

Circular knives are heat treated, to a hardness specified by customer requirements, up to 63 R/C.

Our circular knives are typically made from 52100 steel, but are also available in other tool steels such as D2 or M2. Others materials are also available for quote.

PORTAGE KNIFE COMPANY MANUFACTURER OF SCORE SLITTERS AND PERFORATORS
A DIVISION OF PORTAGE MACHINE CONCEPTS, INC. AKRON, OHIO (330) 784-0700

360-30 Circular Knife

SIZE A	DWG NAME: W360-30.dwg
-----------	--------------------------

This print and the intellectual content is the property of Portage Machine Concepts, Inc. and must not be copied, transmitted or disseminated, in any way, without the written permission of Portage Machine Concepts, Inc.

SCALE: NONE	DATE: 09/22/2017	DRAWN: D. MILLER	SHEET: 1 OF 1
-------------	------------------	------------------	---------------